

HiFLUX

High Pressure Valves & Fittings



HIGH SERVICE
HIGH QUALITY
HIGH PERFORMANCE
High Pressure equipment

HiFLUX

CONTENTS

Hydrogen Fuel Station Needle Valve	05
High Pressure Needle Valve	06
3way/2stem Needle Valve	11
High Pressure Check Valve & Line Filter	12
High Pressure Fitting	14
High Pressure Fitting Accessory	16
Tube Cap / Oil Based Thread Lubricant	17
Safety Head & Rupture Disc	18
High Pressure Ball Valve	19
Relief Valve - Factory Set	22
Relief Valve - Field Adjustable	23
Relief Valve - Proportional Type	25
Air Operated Valve	27
Wellhead Gauge Valve	30
Bleed Valve	31
Double Block and Bleed Valve	32
High Temperature Valve	33
Control Valve	34
High Pressure Tube	35
High Pressure Nipple	36
Tooling Set	37
Tube Support	38
High Pressure Union & Adapter	40
High Pressure Manifold Block	46
Regulator	48
Air Operating BPR	50
Pressure Gauge / Thermocouples	51
Lok Fitting & Valve	52
Piping Materials	53
Port Type	56
Technical Information	60

HiFLUX



Passion for a high-pressure future, constant challenge and innovation

HIFLUX Co., Ltd. has been recognized for its technological prowess by successfully producing various of high-pressure piping materials that are difficult to manufacture domestically through continuous R&D and facility investment to open up new markets in the ultra-high pressure piping materials sector.

Based on differentiated technological prowess and price competitiveness compared to overseas manufacturers in Europe and the United States, it is growing into a global brand by concluding OEM supply contracts with domestic OEM suppliers and overseas global waterjet manufacturers.

In addition, in order to open up new markets, we have developed air-operated valves, high-pressured pressure regulators, back pressure regulators, and other fittings for various purposes and pressure-specific accessories, and now our products are being applied to mass production facilities in various industries.

Expanding R&D investment to achieve carbon neutrality

In order to contribute to carbon neutrality, HIFLUX has researched and developed manual valves for hydrogen refueling stations with pure domestic capital and technology, obtained KS certification, and is currently being supplied to hydrogen refueling station plant sites. It is also developing check valves and pneumatic valves (AOV) KS propulsion and valves for liquefied hydrogen.

In addition, based on its technology related to high-pressure piping for hydrogen refueling stations, it was selected as a hydrogen specialized company by the Ministry of Trade, Industry and Energy in 2024. We will continue to do our best to contribute to the development of the hydrogen industry through steady investment and marketing.

We will always listen to our customers' voices and contribute to productivity and quality improvement through continuous product improvement and service provision, and strive to become HIFLUX that can grow and develop together with our customers.

Thank you.

HIFLUX Co., Ltd. | CEO *Kim Hyeon Hyo*

Overview

Company name	HIFLUX Co., Ltd.	CEO	Kim Hyeon Hyo
Date of Establishment	May 26, 2010	Business Area	Various valves, hydraulic equipment, pumps, etc
Address	(34037) Da Dong, 361-33, Gapcheon-ro, Yuseong-gu, Daejeon, Republic of Korea	Telephone	+82 042-933-5670 (Extension number 1.Technical Sales Department 2.Design Department 3.Public Relations Department 4.Purchasing Department 5.Production Department)
E-mail	Technical Sales Dept : sales@hiflux.com Promotion Dept : min@hiflux.com	Main Product	Needle Valve, Check Valve, Ball Valve, Relief Valve, Air Operated Valve, High-Temp Valve, Control Valve, Fitting, Fitting Accessory, Tube, Nipple, Regulator, Union, Adapter, Tube Support, Radiating Pipe, Pressure Gauge, Tooling Set, Lok Type Products

HIFLUX HISTORY

- 2024.05. Selected as a 'Hydrogen Specialist Company' by Government
- 2023.10. Acquired 'KS certification for manual valve for hydrogen refueling station' by KGS
- 2023.05. KS Q ISO 45001 certification
- 2023.05. Selected as a 2023 HIFLUX Small Giant Company
- 2021.08. Patent (Double-sealed check valve) acquired
- 2021.07. Received a commendation from KGS
- 2021.03. Patent (High-pressure valve) acquired
- 2020.07. 'Material/Component/Equipment Specialist Company Confirmation' acquired
- 2020.07. Patent (High-temperature/high-pressure valve) acquired
- 2020.06. R&D (Valve and fittings for H70 hydrogen refueling stations)
- 2020.04. Patent (Valves including stem carriers) acquired
- 2020.02. 2 types of valve patents acquired
- 2019.01. Joined the Korea Hydrogen Industry Association
- 2018.09. Moved to new headquarters and factory in Daedeok Techno Valley
- 2018.08. Acquired 'Venture Business Certification' from the Technology Guarantee Fund
- 2018.02. HIFLUX acquired European Standard Certification (CE)
- 2016.09. Self-developed 3 types of high-pressure valves
- 2016.04. Self-developed high-pressure Trunnion Ball Valve
- 2015.11. Self-developed high-pressure relief valve
- 2015.11. Factory expansion
- 2015.10. High pressure manifold block, high pressure ball valve self-development
- 2015.08. High pressure relief valve, high pressure needle valve self-development
- 2014.07. Corporate research institute certification
- 2013.10. KS Q ISO 9001 certification, KS I ISO 14001 certification
- 2010.05. Establishment of HIFLUX

Certification Patents



Certificate of Hydrogen Specialist Company



KS Certificate of Needle valve for Hydrogen Station



ISO 9001, 14001, 45001 (Quality, Environment, Health)



CE Certifications



Certificate of Corporate Research Institute



Certificate of Small and Medium Enterprise



Certificate of Materials/Parts/Equipment Specialist Enterprise

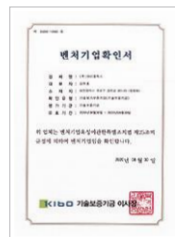

Certificate of Venture Enterprise



Hydrogen Association Membership Card

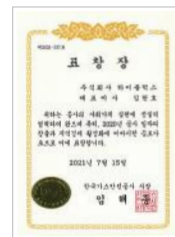

Gas Safety Corporation Award



Patent Certificate / Trademark Registration Certificate

Catalog Numbering System

simply indicate catalog number and specify option or special requirement

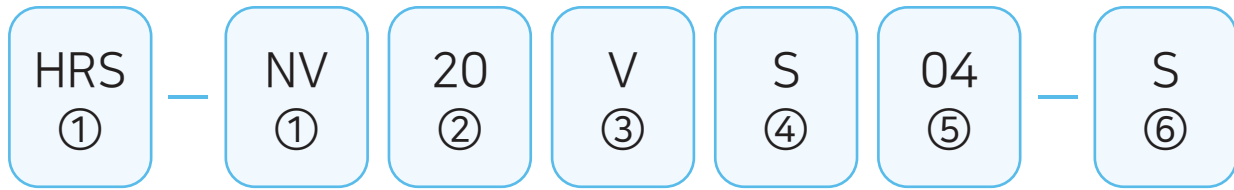

① Products	② Pressure	③ Type of Components	④ Material	⑤ Tube Size	⑥ Options
HRS-NV : Hydrogen Refueling System Needle Valve	03 : 3,000 psi	Needle Valve - V : Vee Stem - R : Regulating Stem	S : Stainless Steel 316	02 : 1/8 inch 04 : 1/4 inch	Needle Valve Control Valve Air Operated Valve High Temperature Valve
NV : Needle Valve	07 : 7,500 psi	Check Valve - O : O-Ring Type - B : Ball Type	H : Hastelloy	06 : 3/8 inch	- S : Straight Type - A : Angle Type
CV : Check Valve	15 : 15,000 psi	Ball Valve	HC : Hastelloy C276 Wetted Part	08 : 1/2 inch	- O : 3way/1on Type - T : 3way/2on Type - D : 3way 2stem Type
BV : Ball Valve	20 : 20,000 psi	- 03 : Orifice 4.8mm - 05 : Orifice 8mm	IN : Inconel 600	09 : 9/16 inch 12 : 3/4 inch	Ball Valve - 20-90 : 2way - 3-180 : 3way Switching - 3-90 : 3way Diverting
ABV : Actuator Ball Valve	30 : 30,000 psi	Control Valve Air Operated Valve - O : Normal-Open Type - C : Normal-Closed Type	IN625 : Inconel 625	16 : 1 inch	
AOV : Air Operated Valve	60 : 60,000 psi	Relief Valve - FS : Factory Set - FA : Field Adjustable - PP : Proportional Type	IN825 : Inconel 825	15 : 15A 25 : 25A	Relief Valve Field Adjustable - 1 : 1 Inlet - 2 : 2 Inlet
RV : Relief Valve	100 : 100,000 psi	Fitting - E : Elbow Type - T : Tee Type - C : Cross Type	NI : Nickel 200		Proportional Type - N : NPT Inlet port
SH : Safety Head	150 : 150,000 psi	Fitting Accessory - A : Adapter - S : Sleeve - G : Gland - R : Collar - T : Collet	TI : Titanium		Fitting Accessory - AV : Anti-Vibration Type
CON : Control Valve	N : NPT P : PT				GPR - N : Normal Type - P : Panel Type
HV : High Temperature Valve					
GV : Wellhead Gauge Valve					
BLV : Bleed Valve					
DBBV : Double Block and Bleed Valve					
FT : Fitting					
FA : Fitting Accessory					
MF : Manifold Block					
FATC : Tube Cap					
T : Tube					
N : Nipple					
A : Adapter					
BPR : Back Pressure Regulator					
HPR : High Pressure Regulator					
GPR : General Pressure Regulator					
ABPR : Air Operating Back Pressure Regulator					

Example

- NV60VS06-A : Needle Valve, 60,000 psi, Vee Stem, 3/8", Angle Type.
- NV15VS04-O : Needle Valve, 15,000 psi, Vee Stem, 1/4", 3Way/1on Pressure Type.
- AOV60CS04-A : Air Operated Valve, 60,000 psi, Normal-Closed, 1/4", Angle Type.
- FT60ES06 : Fitting, 60,000 psi, Elbow Type, 3/8".
- FA60GS04-AV : Fitting Accessory, 60,000 psi, Gland, 1/4", Anti-Vibration Type.

High Pressure Manifold Block

Connects or distributes tubes of various sizes with different pressure specifications into one block

The HIFLUX Manifold Block is a product for connecting or distributing tubes of the same size with the same pressure specifications or tubes of different sizes with different pressure specifications into a single block. We can also manufacture products with the customer's desired specifications and specifications, and with a combination of multiple port types.



Features

- Stainless Steel 316 cold material
- Usage temperature: -423°F (-252°C) to 1200°F (649°C)
- Can be manufactured to customer's desired size and specifications (please contact customer service center)
- Products combined with various port types can also be manufactured (please contact customer service center)

4-way Type

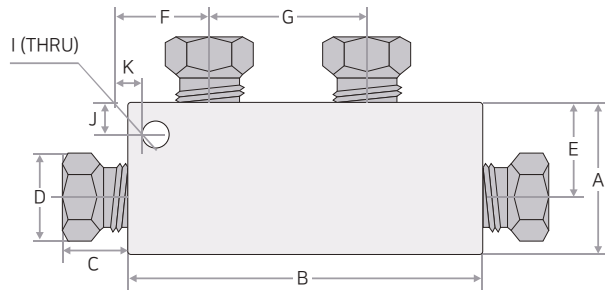

(Unit : mm)

Catalog No	Pressure Rating	Port Type	Tube Size	Orifice Size	Dimensions										Block Thickness
					A	B	C	D (HEX)	E	F	G	I	J	K	
MF15S02-4	15,000 psi	H1502	1/8"	1.4	25	68	12.1	12	19	19	30	6	7	7	15.5
MF15S04-4		H1504	1/4"	3.2	35	85	11.8	16	25	25	35	6	7	7	20
MF15S06-4		H1506	3/8"	5.5	35	85	14	20	25	25	35	6	7	7	20
MF10S08-4	10,000 psi	H1008	1/2"	9.5	45	128	16.3	25	31.5	31.5	65	6	7	7	25
MF20S04-4		H2004	1/4"	2.8	25	74	10.8	12	17.5	22	30	6	6	7	16
MF20S06-4		H2006	3/8"	5.2	35	85	13.1	16	25	25	35	6	7	7	20
MF20S09-4	20,000 psi	H2009	9/16"	7.9	45	118	16	22	31.5	31.5	55	6	7	7	25
MF20S12-4		H2012	3/4"	11.1	57	151	18.6	30	38	38	75	10	10	10	35
MF20S16-4		H2016	1"	17.5	76	195	21.7	36	52.5	52.5	90	10	10	10	45
MF60S04-4	60,000 psi	H6004	1/4"	2.4	35	80	14.5	16	22.5	22.5	35	6	7	7	25
MF60S06-4		H6006	3/8"	3.2	38	108	17	20	25	31.5	45	6	7	7	25
MF60S09-4		H6009	9/16"	4.8	47.5	171	23.5	30	28.5	48	75	6	7	7	38

All dimensions are for reference only and may differ from actual size.

5-way Type

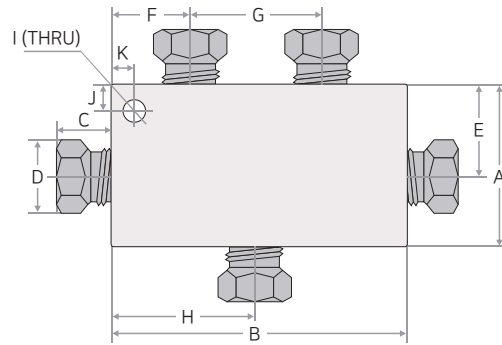

(Unit : mm)

Catalog No	Pressure Rating	Port Type	Tube Size	Orifice Size	Dimensions											Block Thickness
					A	B	C	D (HEX)	E	F	G	H	I	J	K	
MF15S02-5	15,000 psi	H1502	1/8"	1.4	38	68	12.1	12	19	19	30	34	6	7	7	15.5
MF15S04-5		H1504	1/4"	3.2	50	85	11.8	16	25	25	35	42.5	6	7	7	20
MF15S06-5		H1506	3/8"	5.5	50	85	14	20	25	25	35	42.5	6	7	7	20
MF10S08-5	10,000 psi	H1008	1/2"	9.5	63	128	16.3	25	31.5	31.5	65	64	6	7	7	25
MF20S04-5	20,000 psi	H2004	1/4"	2.8	35	74	10.8	12	17.5	22	30	37	6	6	7	16
MF20S06-5		H2006	3/8"	5.2	50	85	13.1	16	25	25	35	42.5	6	7	7	20
MF20S09-5		H2009	9/16"	7.9	63	118	16	22	31.5	31.5	55	59	6	7	7	25
MF20S12-5		H2012	3/4"	11.1	76	151	18.6	30	38	38	75	75.5	10	10	10	35
MF20S16-5		H2016	1"	17.5	105	195	21.7	36	52.5	52.5	90	97.5	10	10	10	45
MF60S04-5	60,000 psi	H6004	1/4"	2.4	50	80	14.5	16	25	22.5	35	40	6	7	7	25
MF60S06-5		H6006	3/8"	3.2	50	108	17	20	25	31.5	45	54	6	7	7	25
MF60S09-5		H6009	9/16"	4.8	67	171	23.5	30	33.5	48	75	85.5	6	7	7	38

All dimensions are for reference only and may differ from actual size.

6-way Type

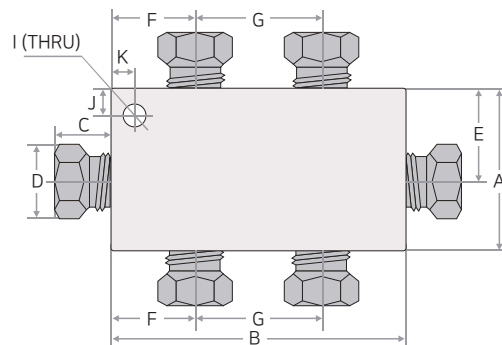

(Unit : mm)

Catalog No	Pressure Rating	Port Type	Tube Size	Orifice Size	Dimensions											Block Thickness
					A	B	C	D (HEX)	E	F	G	I	J	K		
MF15S02-6	15,000 psi	H1502	1/8"	1.4	38	68	12.1	12	19	19	30	34	6	7	7	15.5
MF15S04-6		H1504	1/4"	3.2	50	85	11.8	16	25	25	35	42.5	6	7	7	20
MF15S06-6		H1506	3/8"	5.5	50	85	14	20	25	25	35	42.5	6	7	7	20
MF10S08-6	10,000 psi	H1008	1/2"	9.5	63	128	16.3	25	31.5	31.5	65	64	6	7	7	25
MF20S04-6	20,000 psi	H2004	1/4"	2.8	35	74	10.8	12	17.5	22	30	37	6	6	7	16
MF20S06-6		H2006	3/8"	5.2	50	85	13.1	16	25	25	35	42.5	6	7	7	20
MF20S09-6		H2009	9/16"	7.9	63	118	16	22	31.5	31.5	55	59	6	7	7	25
MF20S12-6		H2012	3/4"	11.1	76	151	18.6	30	38	38	75	75.5	10	10	10	35
MF20S16-6		H2016	1"	17.5	105	195	21.7	36	52.5	52.5	90	97.5	10	10	10	45
MF60S04-6	60,000 psi	H6004	1/4"	2.4	50	80	14.5	16	25	22.5	35	40	6	7	7	25
MF60S06-6		H6006	3/8"	3.2	50	108	17	20	25	31.5	45	54	6	7	7	25
MF60S09-6		H6009	9/16"	4.8	67	171	23.5	30	33.5	48	75	85.5	6	7	7	38

All dimensions are for reference only and may differ from actual size.

Port Type

Low Pressure Port Type

▶ Sleeve Type Connections - 10,000 psi / 15,000 psi

Sleeve Type is a method of attaching a sleeve inside a gland and can be used on 1/8", 1/4", 3/8", and 1/2" pipes. The tubes used for connecting products can be ordered from HIFLUX Mall and are made of stainless steel to ensure optimal performance in high-pressure environments.

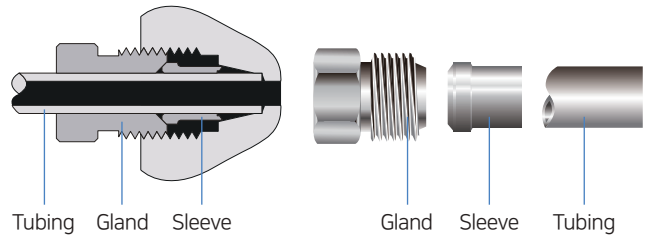

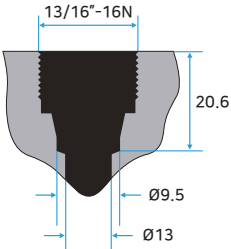
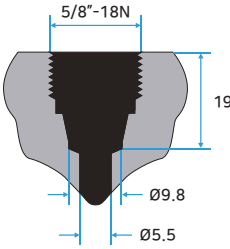
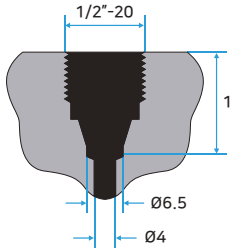
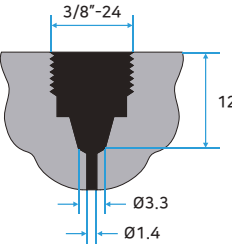
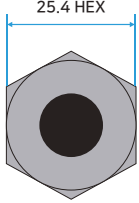
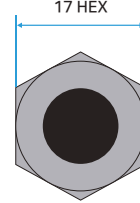
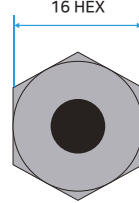
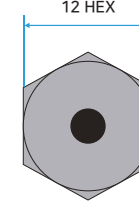
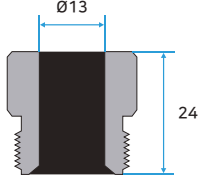
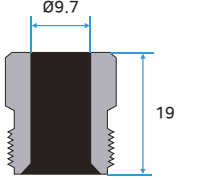
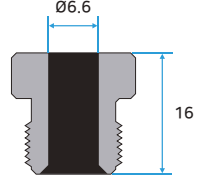
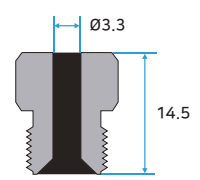
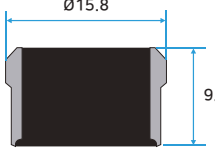
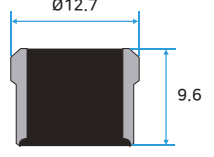
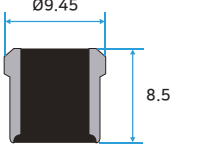
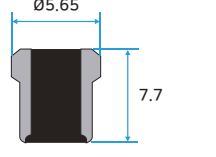
H1008 10,000psi - 1/2"	H1506 15,000psi - 3/8"	H1504 15,000psi - 1/4"	H1502 15,000psi - 1/8"
			
			
			
			

Port Type

Medium Pressure Port Type

Medium Pressure Connections - 20,000 psi

Products are connected using Collar and Nipple within the Gland, and the Nipple required for connecting products can be ordered in the desired length by the user, and can also be processed directly using our tooling set.

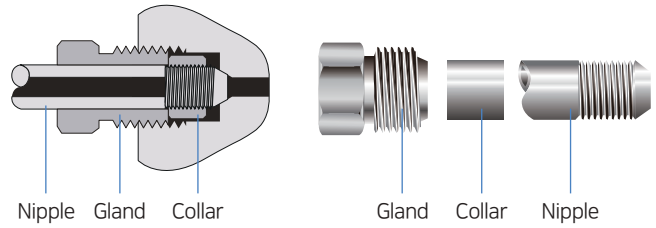

H2004 20,000psi - 1/4"	H2006 20,000psi - 3/8"	H2009 20,000psi - 9/16"	H2012 20,000psi - 3/4"	H2016 20,000psi - 1"
<p>7/16"-20 12.7 60° Ø4.8 Ø2.8</p>	<p>9/16"-18 15.8 Ø7.9 Ø5.2</p>	<p>13/16"-16 19 Ø12.8 Ø7.9</p>	<p>3/4"-14 23.9 Ø15.8 Ø11.1</p>	<p>1-3/8"-12 33.3 Ø22.4 Ø14.3</p>
<p>12 HEX 16</p>	<p>16 HEX 20</p>	<p>22 HEX 25</p>	<p>30 HEX 29</p>	<p>36 HEX 29</p>
<p>Ø9.5 5.5 1/4"-28 LH</p>	<p>Ø11.9 6.4 3/8"-24 LH</p>	<p>Ø18.3 8 9/16"-18 LH</p>	<p>Ø23.8 9.5 3/4"-16 LH</p>	<p>Ø31 12.5 1"-14 LH</p>
<p>Ø6.35 26.5 Ø9.3 Ø3.57</p>	<p>Ø9.53 32 Ø11.7 Ø6.35</p>	<p>Ø14.29 42 Ø18.1 Ø10.32</p>	<p>Ø19.05 45.5 Ø23.6 Ø14.29</p>	<p>Ø25.4 60 Ø30.7 Ø18.26</p>
<p>1/4"-28 LH 9 Ø3.57 Ø2.77</p>	<p>3/8"-24 LH 11 Ø6.35 Ø5.16</p>	<p>9/16"-18 LH 13 Ø10.32 Ø7.92</p>	<p>3/4"-16 LH 16 Ø14.29 Ø11.12</p>	<p>1"-14 LH 20 Ø18.26 Ø14.27</p>

Port Type

High Pressure Port Type

High Pressure Connections - 30,000 psi / 60,000 psi

The Nipple required for connection between the products by using collar and Nipple in the Gland can be ordered by user's desired length. you can also process directly using our Tooling Set tool. this cone and threaded connection is the standard for easy and fast high-pressure equipment configuration with optimum sealing and reliable performance for both liquid and gas at high pressure and temperature.

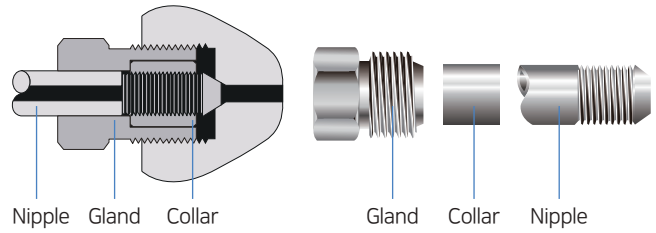

H3002 30,000psi - 1/8"	H3016 30,000psi - 1"	H6004 60,000psi - 1/4" (M : Metric)	H6006 60,000psi - 3/8" (M : Metric)	H6009 60,000psi - 9/16" (M : Metric)

Port Type

Ultra High Pressure Port Type

Ultra High Pressure Connections - 100,000 psi / 150,000 psi

The product is connected using a collar and nipple within the gland, and the corresponding pipe sizes are as follows. This Cone and Thread method connection is the optimal sealing method, and it provides reliable performance for both liquids and gases at high pressures and temperatures, and is the standard for easy and quick high-pressure equipment configuration.

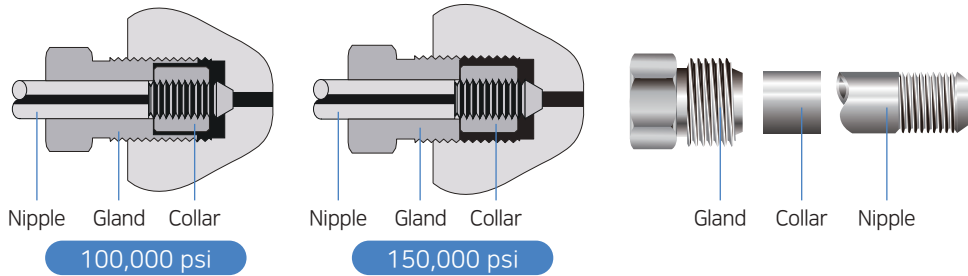

H10004 100,000psi - 1/4"	H10006 100,000psi - 3/8"	H10009 100,000psi - 9/16"	H15006 150,000psi - 3/8"

Technical Information

Recommended Torque

Recommended Minimum Bend Radius

Tubing Size O.D. x I.D. in. (mm)	Tubing Pressure psi (bar) @ R.T.	Recommended Minimum Bend Radius in. (mm)
1/4 inch (6.35 x 2.77)	20,000 (1,370)	1.25 (31.8)
3/8 inch (9.53 x 5.16)	20,000 (1,370)	1.75 (44.5)
9/16 inch (14.29 x 7.92)	20,000 (1,370)	2.63 (66.8)
3/4 inch (19.05 x 11.13)	20,000 (1,370)	3.50 (88.9)
1 inch (25.4 x 14.27)	20,000 (1,370)	4.63 (117.6)
1 inch (25.4 x 11.13)	30,000 (2,060)	4.63 (117.6)
1/4 inch (6.35 x 2.11)	60,000 (4,130)	1.25 (31.8)
3/8 inch (9.53 x 3.18)	60,000 (4,130)	1.75 (44.5)
9/16 inch (14.29 x 4.78)	60,000 (4,130)	2.63 (66.8)

All dimensions are for reference only and may differ from actual size.

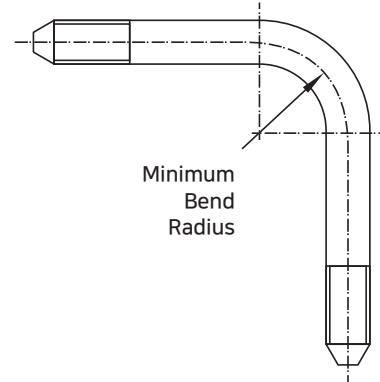

HIFLUX Needle Valve Assembly Torque Chart

Valve Pressure Series	Port Type	Tube Size (PSI)	Stem Gland HEX (mm)	Minimum Torque (kg.f-cm)
10,000 PSI 15,000 PSI	H1502	1/8 Inch (15,000)	13	170
	H1504	1/4 Inch (15,000)	17	550
	H1506	3/8 Inch (15,000)	17	550
	H1008	1/2 Inch (15,000)	24	800
20,000 PSI	H2004	1/4 Inch (20,000)	17	550
	H2006	3/8 Inch (20,000)	17	550
	H2009	9/16 Inch (20,000)	22	1100
	H2010	3/4 Inch (20,000)	30	3,500
	H2012	1 Inch (20,000)	41	5,000
30,000 PSI	H3002	1/8 Inch (30,000)	13	500
	H6004	1/4 Inch (30,000)	20	550
	H6006	3/8 Inch (30,000)	20	550
	H6009	9/16 Inch (30,000)	20	550
60,000 PSI	H6004	1/4 Inch (60,000)	20	670
	H6006	3/8 Inch (60,000)	20	670
	H6009	9/16 Inch (60,000)	20	670
100,000 PSI	H10004	1/4 Inch (100,000)	24	1250
	H10006	3/8 Inch (100,000)	24	1250
	H10009	9/16 Inch (100,000)	24	1250
150,000 PSI	H15006	3/8 Inch (150,000)	24	1870
10,000 & 15,000 PSI NPT TYPE	HFN02	1/8 Inch (15,000)	13	500
	HFN04	1/4 Inch (15,000)	17	550
	HFN06	3/8 Inch (15,000)	17	550
	HFN08	1/2 Inch (15,000)	22	1100
	HFN10	3/4 Inch (10,000)	41	-
	HFN12	1 Inch (10,000)	41	-

Torque values apply to glass-impregnated Teflon packaging and may vary by ±10%



HIFLUX[®]

HIFLUX Co., LTD



361-23, Gapcheon-ro, Yuseong-gu, Daejeon,
34037, Republic of Korea

Phone & Fax



TEL. +82-42-933-5670
FAX. +82-0303-0799-1241

E-mail & Online



E-mail. sales@hiflux.com
Web. www.hiflux.net
Shopping Mall. www.hifluxshop.com

